

Ashland Lavatory Faucet



Specifications

Flow Rate (GPM)	1.3GPM @ 60 psi
Material Content	AB1953 platform hybrid body with zinc handle
Pop-Up Drain	Brass pop-up
Spout Reach	4-3/16"
Cartridge	Ceramic disc
Lever Handle Operation	(1/4) quarter turn stop
Installation Type	3-hole, 4" center mount



Dimensions

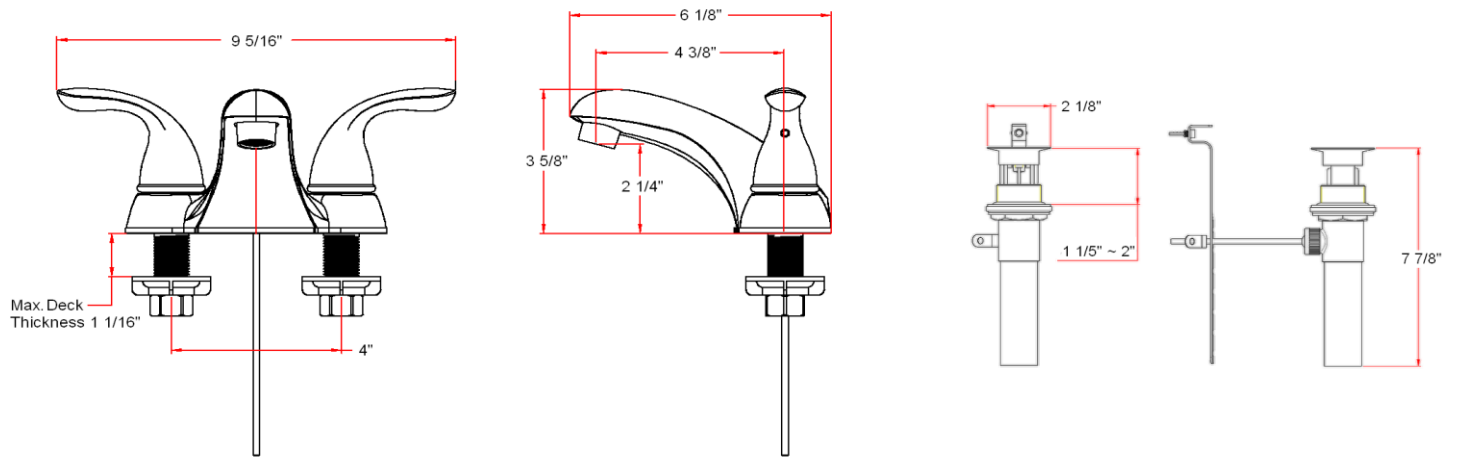

Warranty & Compliances

Warranty	Lifetime Limited Warranty
IAPMO/UPC	UPC & cUPC Compliant
ASME	ASME A112.18.1-05
ANSI	Compliant
ADA	Compliant
NSF	Compliant
Lead Free	Fed. P.L. 111-380 (1/2014)
Watersense	Compliant



Order Codes & Finishes/Colors

Polished Chrome (US26)	524983	
Satin Nickel (US15)	524991	
Oil Rubbed Bronze (US10B)	525006	

Type:

Job:

Order Code:

Approvals:

Design House reserves the right to make changes in materials, specifications & models at any time. Design House also reserves the right to discontinue product without notice or obligation.