

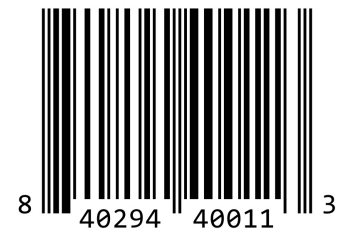

T-LOC
2015-12DS



Tools Needed

Measuring tape	Pencil	Drill
Laser level (optional)	Impact driver	1/4" drill bit
Level	#1 square drive bit	1/2" drill bit
Stud finder	Phillips screwdriver	3/16" Allen wrench

Parts Included

[2] Shelf bracket arms	[2] Snap toggles
[2] Base plates	[2] 2.5" bolts
[2] 1/2" grub screws	[2] 1.5" self-tapping trim screws
[2] 1" grub screws	[2] 1" self-tapping trim screws
[2] Drywall plates	[1] 5/32" drill bit

Installation Instructions

Step 1: Using a laser level or level as a guide, draw a horizontal line on the selected wall or area at the desired installation height taking into account the thickness of the shelf top. The line must be as long as the shelf that's being installed.

Step 2 [Steel Stud Only]: Use a stud finder to find wall studs to mount your brackets on within the length of the horizontal line. Use a pencil to draw a vertical line in the center of each stud up 1" from the horizontal line.

Step 3: Place the provided adhesive mounting template on the wall where the shelf bracket will be fastened. The top edge of the template should be on the horizontal line. For steel studs, the vertical center line should match the vertical line on the wall.

Step 4: Pre-drill the top hole using a drill and a 1/4" bit, drilling through the center of the top dot on the mounting template. Finish the hole with a 1/2" bit. For steel stud installations, use a 1/2" bit to drill the bottom hole to, but not through, the stud.

Step 5: Insert the snaptoggle into the top hole, orienting it vertically with the cap up. Tighten the center retainer and snap off the plastic legs.

Step 6 [Drywall]: Align the hole on the drywall plate with the top hole on the base plate, then slide the 2.5" bolt through both holes and thread it into the snaptoggle. Hand-tighten with a screwdriver. Thread the 1/2" grub screw into the base plate.
(The 1" grub screw is not used for drywall applications)

Step 6 [Steel Stud]: Slide the 2.5" bolt through the top hole of the base plate and thread it into the snaptoggle. Hand-tighten with a screwdriver. Thread the 1" grub screw into the base plate.
(The 1/2" grub screw and drywall plate are not used for steel stud applications)

Step 7: Lock the shelf bracket arm into the base plate.

Step 8: To level the bracket, place a level on top of the bracket arm and, using a 3/16" Allen wrench, rotate the grub screw clockwise or counter-clockwise. Make sure to level the brackets with each other.

Repeat steps 3-8 for each shelf bracket.

Step 9: Slide the shelf onto the shelf brackets and push it firmly against the wall. Measure 2" out from the lines drawn in step 2 and use a drill with the 5/32" bit to drill to, but not through, the bracket. Use an impact with a #1 square drive bit to drive a 1" self-tapping screw (for shelves with 1/2" top thickness) or a 1.5" self-tapping screw (for shelves with more than 1/2" top thickness) through each hole and into the brackets to secure the shelf to the wall.

1

Draw horizontal line at installation height

2 [Steel Stud Only]

Find stud center and draw 1" vertical line

3

Align template with line

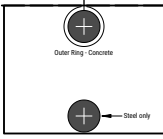

4

Drill with 1/4" bit, then with 1/2" bit

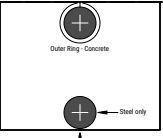

[Steel Stud Only]
Drill to, but not through, stud with 1/2" bit

5

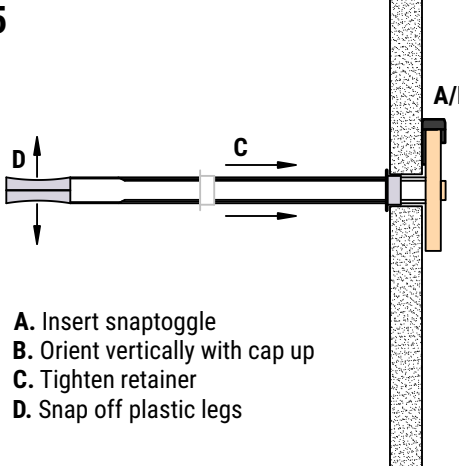

A. Insert snaptoggle
B. Orient vertically with cap up
C. Tighten retainer
D. Snap off plastic legs

6 [Drywall]

A. Slide bolt through base plate and drywall plate and thread into snaptoggle

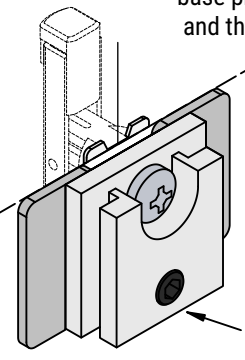

B. Thread 1/2" grub screw into base plate

(1" grub screw not used for drywall)

6 [Steel Stud]

A. Slide bolt through base plate and thread into snaptoggle

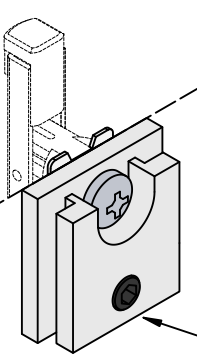

B. Thread 1" grub screw into base plate

(1/2" grub screw and drywall plate not used for steel stud)

7

Lock bracket arm into base plate

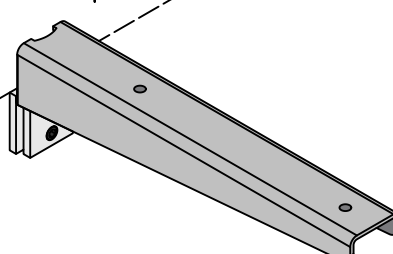

8

Adjust angle with 3/16" allen wrench to level bracket

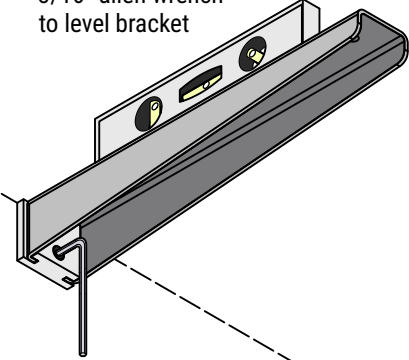

9

Seat shelf against wall, drill hole and secure with self-tapping trim screw

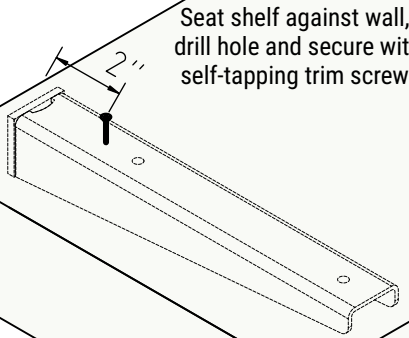

Discover more products by visiting us online. Just scan this **QR code** or visit www.innovashelf.com to find inspiration photos, bracket specs, other products, and information about purchasing more brackets or buying wholesale.