

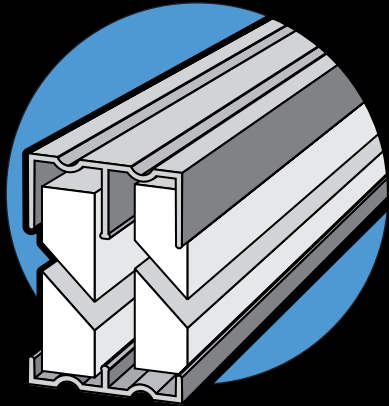

for 1/2 inch thick

wood, plywood,
fiber board, etc.

TRACK ASSEMBLY No 13



- Silent, smooth operation
- Economical and quick install
- High impact extruded polystyrene plastic

PACKAGE CONTAINS:

- 1pc. #2212 upper guide
- 1pc. #212 lower track
- 4pc. #33 button glides

for 1/2 inch thick bypassing doors

www.epcohardware.com

PART IDENTIFICATION:

1 pc. #2212 upper guide

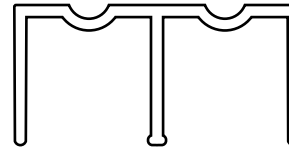

1 pc. #212 lower track



4 pc. #33 button glides

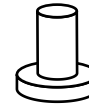

CAUTION: Do not wax or paint track or guide.

The plastic bottom track and upper guide are designed to provide a finished frame but may be covered with trimboard or recessed if desired.

Nylon button glides install into a 1/4" diameter hole in the bottom of the sliding door panel. Use two per door.

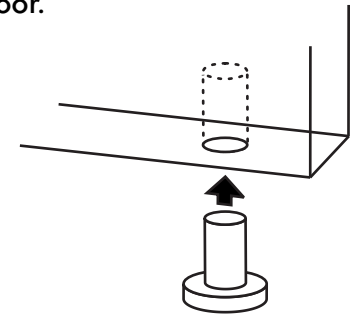

SURFACE INSTALLATION

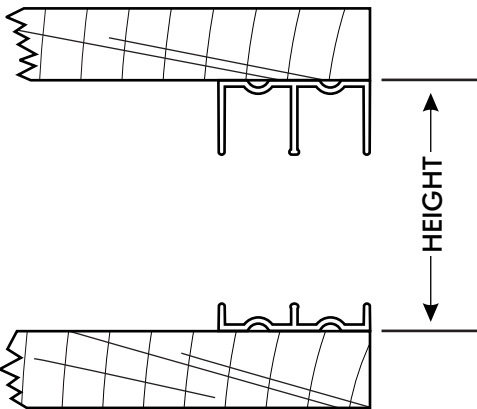

TO OBTAIN PANEL HEIGHT

Cut panel 7/16" less than height of finished opening.

TO OBTAIN PANEL WIDTH

Add 1/2" to opening width and divide by 2 for 1/2" overlap.

Add 1" to opening width and divide by 2 for 1" overlap.

Use glue or brads to fasten track and guide to mounting surface.

RECESSED INSTALLATION

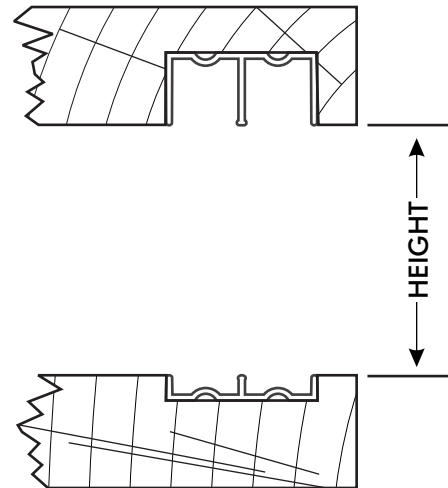

TO OBTAIN PANEL HEIGHT

Cut panel 7/16" larger than height of finished opening.

TO OBTAIN PANEL WIDTH

Add 1/2" to opening width and divide by 2 for 1/2" overlap.

Add 1" to opening width and divide by 2 for 1" overlap.

Use glue or brads to fasten track and guide to mounting surface.



www.epcohardware.com