



# Pockit<sup>®</sup> Plus 1.5W

12VDC PUCK LIGHTING



45 Lumens



Pockit® Plus features clean and simple lines PLUS cutting-edge bulb technology that provide powerful, bright light without the energy consumption and heat. Performance and effortless installation for recess or surface mounting all at a competitive price — that’s the power of PLUS.



▶ Thin profile: Just 1/4" (6 mm) depth when recessing  
3/8" (9.5 mm) when surface mounting



▶ Available in 4 finishes

**Features:**



- ▶ 90° beam spread
- ▶ Surface mount ring included
- ▶ Dimmable

**Typical Applications:**

- ▶ Displays
- ▶ Mid-level flood light
- ▶ Interior cabinets
- ▶ Under cabinets

**Available Finishes:**

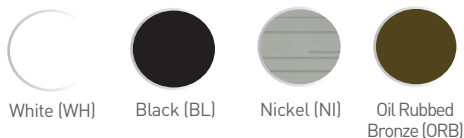

**Dimensions:**

Actual Size





**Specifications:**

Wattage	1.5W
Lumens	45
Efficacy (lm/W)	30
Input Voltage	12VDC
Diode Life	25,000 Hours
Max Per 60W Power Supply	40 Fixtures
Max Continuous Run	N/A
Mounting	Recess/Surface
Warranty	1 Year
Certifications	

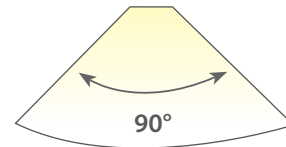
**Beam Angle**



**Photometric Data**

	Height	Light Output	Beam Area
	1ft (.3 m)	18.50Fc (198lx)	2.4ft L x 2.4ft W (0.7 m L x 0.7 m W)
	3ft (.9 m)	2.06Fc (22.2lx)	7.2ft L x 7.2ft W (2.2 m L x 2.2 m W)
	6ft (1.8 m)	.51Fc (5.5lx)	14.4ft L x 14.4ft W (4.4 m L x 4.4 m W)

L-POC-1LEDSFR-C Tested

**Color Temperature**

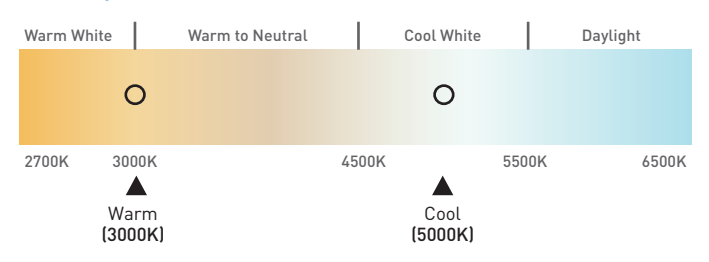

IES data verified by Intertek testing lab.

**Required Items**

**Pockit® Plus 1.5W**

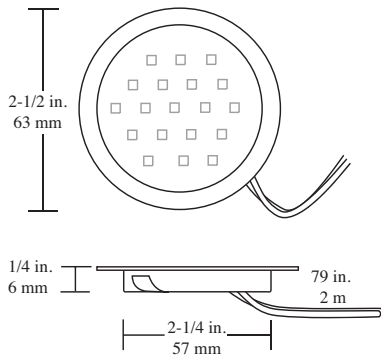

Part #	Description
L-POC-1LEDSFR-CBL-1	1.5W 5000K Black LED Metal Pockit® Light
L-POC-1LEDSFR-CNI-1	1.5W 5000K Nickel LED Metal Pockit® Light
L-POC-1LEDSFR-CORB-1	1.5W 5000K Oil Rubbed Bronze Pockit® Light
L-POC-1LEDSFR-CWH-1	1.5W 5000K White LED Metal Pockit® Light
L-POC-1LEDSFR-WBL-1	1.5W 3000K Black LED Metal Pockit® Light
L-POC-1LEDSFR-WNI-1	1.5W 3000K Nickel LED Metal Pockit® Light
L-POC-1LEDSFR-WORB-1	1.5W 3000K Oil Rubbed Bronze Pockit® Light
L-POC-1LEDSFR-WWH-1	1.5W 3000K White LED Metal Pockit® Light

2-1/4" (57 mm) hole required for recessed mounting.  
 25,000 useful life hours.  
 Pockit® Plus Includes 79" (2 m) Starter Cord, Surface Mount Ring, and AMP® Connector.

**Surface Mount Ring**

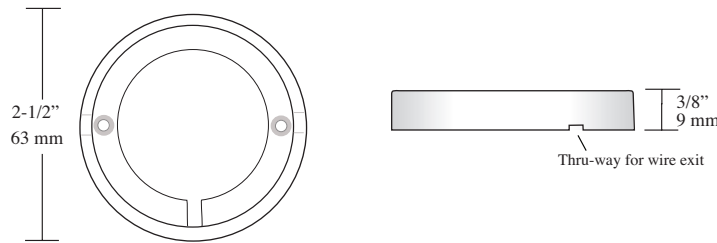

Surface Mount Ring is included with each light.

**Power Supplies**



Part #	Description
L-DC-ELT12-CON-1	12W 12VDC Power Supply w/6 Snap Mounting Block*
L-DC-ELT18-CON-1	18W 12VDC Power Supply w/6 Snap Mounting Block*
L-DC-ELT60-CON-1	60W 12VDC Power Supply w/6 Snap Mounting Block*
L-DC-ELT6WP-CON-1	6W 12VDC Wall Mount Power Supply w/3 Snap Block*
L-DC-ELT15WP-CON-1	15W 12VDC Wall Mount Power Supply w/6 Snap Block*
L-DCE12D-CON-1	12VDC 12W Dimmable LED Power Supply
L-DCE50D-CON-1	12VDC 50W Dimmable LED Power Supply

\* Dimmable on trailing edge (12V side). Mounting block and power cord are included.