

The Tri-Mitter must be positioned at a distance of at least 0,5m from electronic devices, ballasts or cables.  
Do not install the Tri-Mitter behind mirrors, metal surfaces and metal foils!

Distance du Tri-Mitter par rapport aux appareils électroniques, ballasts, câbles au moins 0,5m!  
Ne pas installer le Tri-Mitter derrière des miroirs, des surfaces métalliques ou des films métalliques!

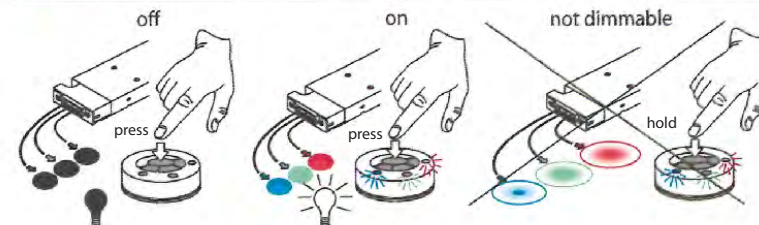

## Wireless Controller installation

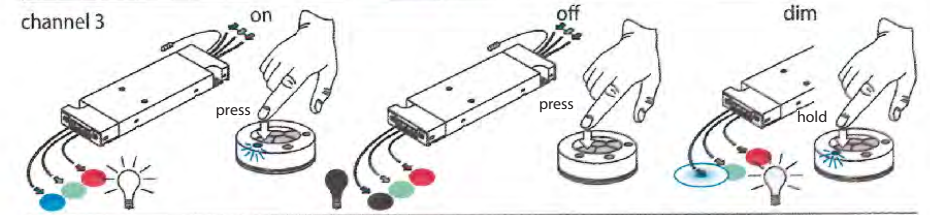
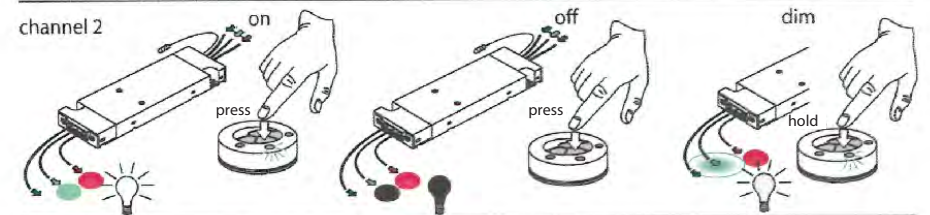
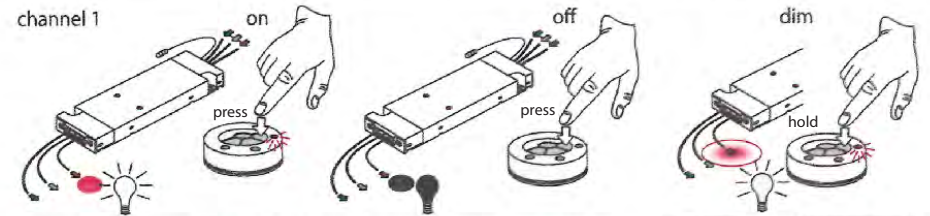
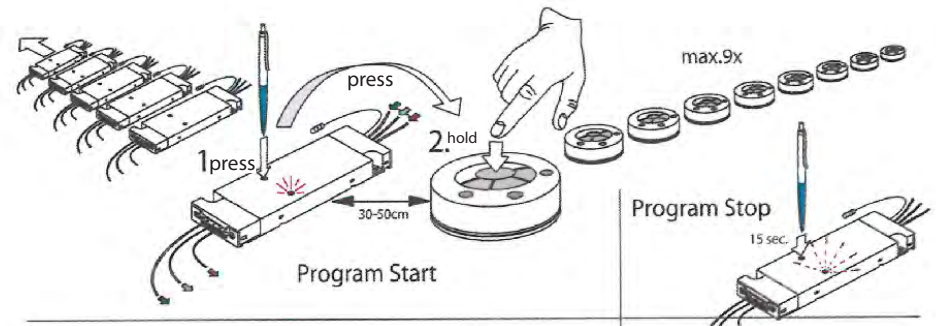
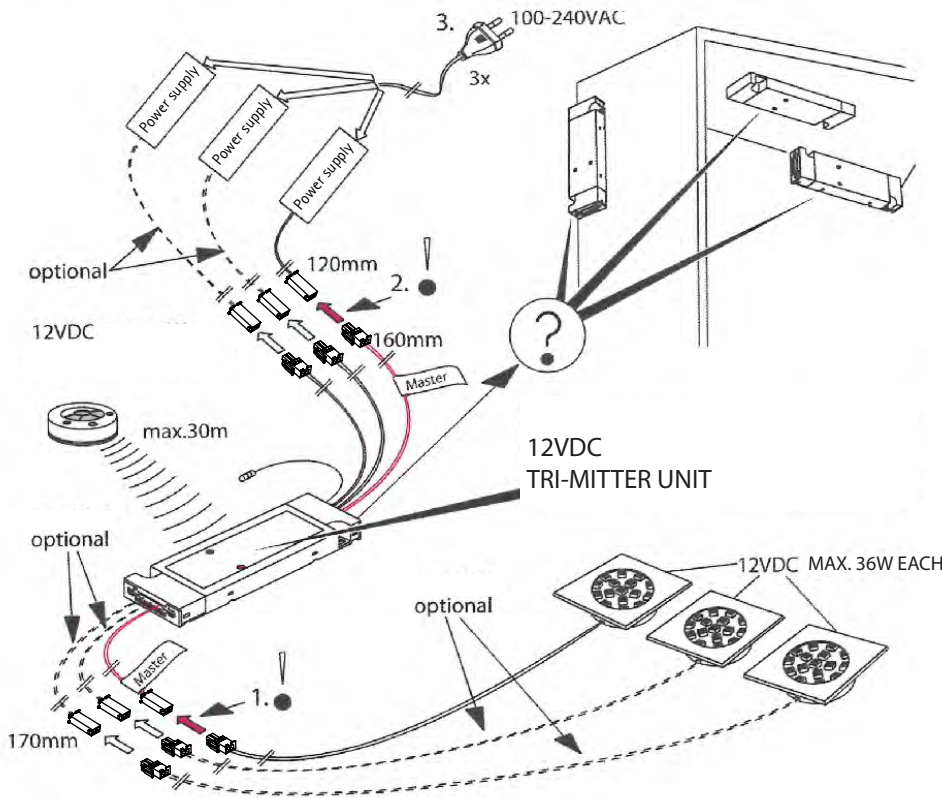
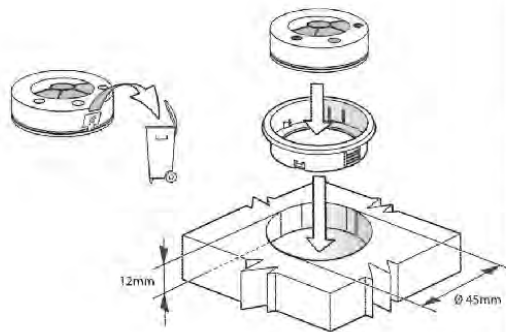

## Changing the battery

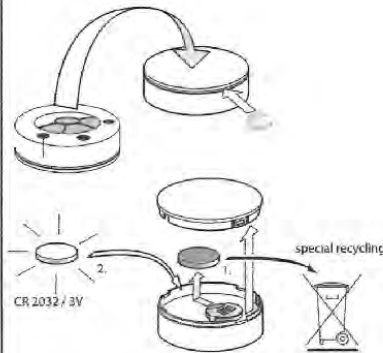

## Programming the Tri-Mitter

For this process, the distance between wireless transmitter and Tri-Mitter should be no greater than 50 cm. As many as 9 different transmitters can be programmed into a Tri-Mitter. The wireless transmitter can be programmed into any number of wireless receivers.

### Programming procedure:

1. For programming purposes, you will find a programming button and an LED indicator on the unit.
2. Press the programming button on the Tri-Mitter (do not hold it down)
3. Hold down the Master button on the controller. Release after Red indicator light on Tri-Mitter goes out and comes back on.
4. Wait approximately 10 Seconds for programming to complete.

### Procedure for de-programming - Clearing the transmitter memory

1. Keep pressing the programming button on the Tri-Mitter. The LEDs starts to flash.
2. Keep button pressed until the LED stops flashing.
3. All transmitters are deleted after letting go of the button

### Technical specifications

#### Wireless hand-held transmitter

Power supply:	3VDC	
Battery:	1x lithium button cell (CR2032)	
Battery life:	approx. 8 months of average use	
Transmission frequency:	433.9 MHz	
Transmission range:	30m max. unobstructed	
3 channel buttons:	tapping - "ON" / "OFF" keeping pressed - dimming	
1 master button:	tapping - "ON" / "OFF"	
Stand-by power consumption:	10uA	
Power consumption while transmitting:	10mA	
Time to dim up / down:	5 sec	
Dimension:	see drawing	

#### Tri-Mitter wireless dimmer

Rated voltage:	12VDC
Switching capacity:	No more than 36W (3x) at 12 VDC

Load types:	LED lights, voltage-controlled without driver
Number of transmitters:	no more than 9
Channel assignment:	automatically on programming the transmitters
Receive frequency:	433.9 MHz
Modulation:	ASK (Amplitude shift Keying)
Terminals:	M1 / M1-F plug system
Dimensions:	167mm x 45mm x 16mm

### Wireless communication

As wireless communication takes place on a non-exclusive communication path, interference cannot be ruled out. Wireless transmission is not suitable for safety applications (emergency OFF or emergency calling). The wireless system is intended for domestic use. The wireless transmitter has a max. transmission range of 30 m in open space.

### Hazard warnings and disposal information

Make sure that the plugged-in load is in safe condition so that it does not present a hazard when it is switched on. The device is only intended for operating and dimming lights. No other terminal devices must be connected to the system. Observe the maximum permissible load of the connected power user/electronic ballast and Tri-Mitter (see Technical specifications). Keep batteries away from children. Call a doctor immediately if batteries are swallowed. Be sure not to insert the batteries the wrong way round by paying attention to the + and - markings on batteries and device. The device is supplied with a standard battery. This battery must not be recharged. Recharging this battery may result in personal injury or damage to property as a result of the battery exploding or leaking. Please follow all of the safety precautions printed on the battery. Never open the battery or throw the battery or device into fire. Always observe your local disposal.

### Operation / Switching 'ON'/OFF' and dimming

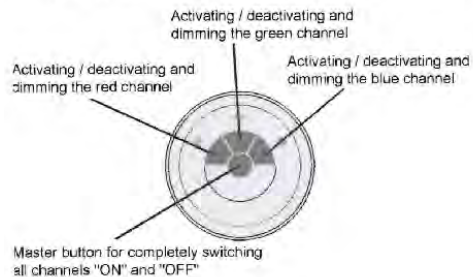

The wireless controller is ready for operation as soon as you remove the battery insulation strip. Each button transmits its own dedicated wireless telegrams. These alternate between a telegram for "OFF" followed by one for switch-"ON"/"OFF" and dimming. The LED lights up when a button is pressed. **Briefly pressing coloured button:** toggles the assigned channel between "ON"/"OFF". **Keeping coloured button pressed:** toggles the assigned channel's dimming function between up / down. **Briefly pressing the master button:** toggles the switching function of all channels between "ON"/"OFF". No dimming. **Information on using several controllers for operating a Tri-Mitter:** as each controller changes the commands every time the button is pressed, an additional controller may have to be pressed twice. This is the case, for example, if transmitter A was used for switching lighting "OFF" and transmitter B has since been used to switch it back "ON" again. In this case, pressing the relevant button would cause transmitter A to send out an "ON" command which would not activate any switching function as transmitter B has already put it into this switching status.

### Connecting the Tri-Mitter wireless controller

Connect to the power supply at the terminals on the Tri-Mitter. Dimming function is only given if the "Master" input is connected. All of the Tri-Mitter's channels are configured separately. One input on each is assigned to the relevant output. This must be labelled on the device (red + "Master" line sticker, green, blue) Load voltage and power output must be appropriate for the selected power supply / electronic ballast. The Tri-Mitter's limit values must be observed. No more than 36 W (3x) for 12 VDC or no more than 72 W for 24 VDC. Electronic ballasts of identical operating voltages can be connected to each of the Tri-Mitter's inputs. Ballasts must not be connected if their voltage differ.